

INSTRUCTION MANUAL
BExS110D-SIL
ALARM HORN SOUNDER – SIL2
ATEX, IECEx & UKEx GAS & DUST

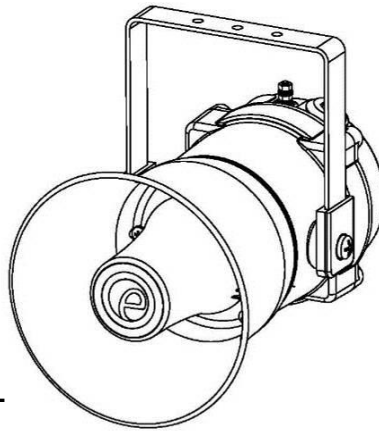

BExS110D-SIL

1) Product Table

Model Number	Nominal Input Voltage	Nominal Input Current	Voltage Range	Sound Pressure Level dB(A)	
				Max*	Nom.†
BExS110DFDC024-SIL	24Vdc	290mA	20-28Vdc	117dB(A)	Flare: 110dB(A)
*Max = Tone 4 †Nom. = Tone 44 The table shows the input current taken by the various sounders. The current levels shown above are for the 440Hz Continuous tone @ nominal input voltage. Nominal current at nominal voltage.					
Table 1: Electrical Ratings.					

It is important that a suitable power supply is used to run the equipment. The power supply selected must have the necessary capacity to provide the input current to all of the units.

The above table shows the input current taken by the various sounders and shows the maximum voltage at which the sounders can be operated:

The input current will vary according to the voltage input level and the frequency of the tone selected.

2) Warnings



- DO NOT OPEN WHEN AN EXPLOSIVE ATMOSPHERE IS PRESENT
- DO NOT OPEN WHEN ENERGIZED
- POTENTIAL ELECTROSTATIC CHARGING HAZARD
- COVER BOLTS CLASS A4-80
- USE HEAT RESISTING CABLES AND CABLE GLANDS (RATED 110°C) AT AMB. TEMPERATURES OVER 40°C

3) Marking & Rating Information

The BExS110D & BExS110D-R Alarm Horns comply with the following standards for hazardous locations:

3.1. ATEX / IECEx & UKEx Ratings

Standards	
EN60079-0:2018/IEC60079-0:2017 (ed.7): Explosive Atmospheres - Equipment General Requirements.	
EN60079-1:2014/IEC60079-1:2014 (ed.7): Explosive Atmospheres - Equipment Protection by Flameproof Enclosures "d".	
EN60079-31:2014/IEC60079-31:2013 (ed.2): Explosive Atmospheres - Equipment Dust Ignition Protection by enclosure "t".	
Model No:	Rating
BExS110D-SIL	Ex db IIC T4 Gb Ta. -50°C to +55°C Ex db IIB T4 Gb Ta. -50°C to +70°C Ex tb IIIC T100°C Db Ta. -50°C to +55°C Ex tb IIIC T115°C Db Ta. -50°C to +70°C
See Product table for electrical ratings of each unit model	

Certificate No. KEMA 99ATEX6312X
IECEX KEM 10.0003X
UL22UKEX2638X

Epsilon x
Equipment Group
and Category:



II 2G
II 2D

CE Marking and
Notified Body No.



2813

UKCA Marking and
Approval Body No.



0518

4) Zones, Gas Group, Category and Temperature Classification

The units can be installed in locations with the following conditions:

Area Classification Gas	
Zone 1	Explosive gas air mixture likely to occur in normal operation.
Zone 2	Explosive gas air mixture not likely to occur in normal operation, and if it does, it will only exist for a short time.
Gas Groupings	
Group IIA	Propane
Group IIB	Ethylene
Group IIC	Hydrogen and Acetylene (up to 55°C ambient)
Temperature Classification for Gas Applications	
T1	450° C
T2	300° C
T3	200° C
T4	135° C
Area Classification Dust	
Zone 21	Explosive dust air mixture likely to occur in normal operation.
Zone 22	Explosive dust air mixture not likely to occur in normal operation, and if it does, it will only exist for a short time.
Dust Groupings	
Group IIIA	Combustible Dusts
Group IIIB	Non-Conductive Dusts
Group IIIC	Conductive Dusts
Equipment Category	
2G, 2D	
Equipment Protection Level	
Gb, Db,	
Maximum Surface Temperature for Dust Applications	
100°C at +55°C 115°C at +70°C	
Ambient Temperature Range	
-50°C to +55°C Gas Groups IIA, IIB and IIC -50°C to +70°C Gas Groups IIA and IIB -50°C to +70°C Dust Groups IIIA, IIIB and IIIC	
IP Rating	
IP66/67 to EN/IEC60529 and IP6X to EN/IEC60079-0, EN/IEC60079-31	
The sounder must only be installed by suitably qualified personnel in accordance with the latest issues of the relevant standards:	
EN60079-14 / IEC60079-14: Explosive atmospheres - Electrical installations design, selection and erection	
EN60079-10-1 / IEC60079-10-1: Explosive atmospheres - Classification of areas. Explosive gas atmospheres	
EN60079-10-2 / IEC60079-10-2: Explosive atmospheres - Classification of areas. Explosive dust atmospheres	
The installation of the sounder must also be in accordance with any local codes that may apply and should only be carried out by a competent electrical engineer who has the necessary training.	

5) Special Conditions of Use

Repair of the flamepath / flameproof joints is not permitted.

The enclosure is non-conducting and may generate an ignition-capable level of electrostatic charges under certain extreme conditions (such as high-pressure steam). The user should ensure that the equipment is not installed in a location where it may be subjected to external conditions that might cause a build-up of electrostatic charges on non-conducting surfaces.

Additionally, cleaning of the equipment should be done only with a damp cloth.

6) Location and Mounting

The location of the sounder should be made with due regard to the area over which the warning signal must be visible. They should only be fixed to services that can carry the weight of the unit.

The BEx sounder should be secured to any flat surface using the three 7mm fixing holes on the stainless steel U shaped mounting bracket. See Figure 1. The required angle can be achieved by loosening the two large bracket screws in the side of the unit, which allow adjustment of the sounder in steps of 18°. On completion of the installation then two large bracket adjustment screws on the side of the unit must be fully tightened to ensure that the unit cannot move in service.

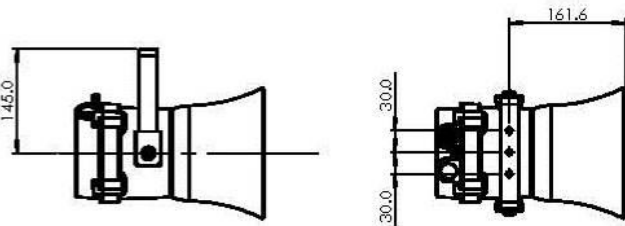

Fig. 1 Fixing Location for S110 Sounder

7) Access to the Flameproof Enclosure



Warning – High voltage may be present, risk of electric shock. DO NOT open when energised, disconnect power before opening.



Warning – Hot surfaces. External surfaces and internal components may be hot after operation, take care when handling the equipment.

To access the Ex d chamber, remove the four M6 hexagon socket head screws and withdraw the flameproof cover taking extreme care not to damage the flameproof joints in the process. M6 cover screws are Class A4-80 stainless steel and only screws of this category can be used for the enclosure.

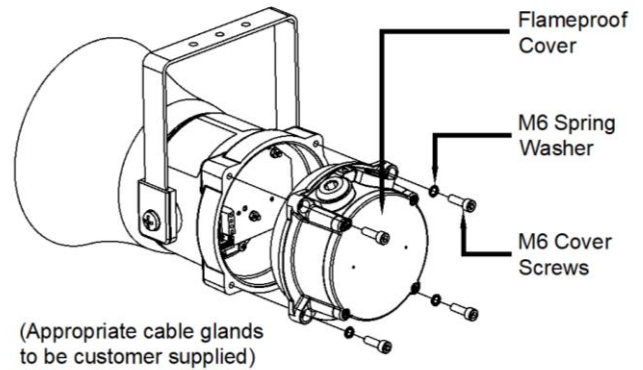

Fig. 2 Accessing the Explosion proof Enclosure.

On completion of the installation, the flameproof joints should be inspected to ensure that they are clean and that they have not been damaged during installation.

Check that the earth bonding wire between the two castings is secure and the 'O' ring seal is in place. When replacing the flameproof cover casting ensure that it is square with the flameproof chamber casting before inserting. Carefully push the cover in place allowing time for the air to be expelled. Only after the cover is fully in place should the four M6 Stainless Steel A4-80 cover bolts and their spring washer be inserted and tightened down. If the cover jams while it is being inserted, carefully remove it and try again. Never use the cover bolts to force the cover into position.

8) Selection of Cable, Cable Glands, Blanking Elements & Adapters

When selecting the cable size, consideration must be given to the input current that each unit draws (see table 1), the number of sounders on the line and the length of the cable runs. The cable size selected must have the necessary capacity to provide the input current to all of the sounders connected to the line.

For ambient temperatures over +40°C the cable entry temperature may exceed +70°C and therefore suitable heat resisting cables and cable glands must be used, with a rated service temperature of at least 110°C

The dual cable gland entries have an M20 x 1.5 entry thread. To maintain the ingress protection rating and mode of protection, the cable entries must be fitted with suitably rated ATEX / IECEx & UKEx certified cable glands and/or suitably rated ATEX / IECEx & UKEx certified blanking devices during installation according to EN / IEC60079-14.

If a high IP (Ingress Protection) rating is required then a suitable sealing washer must be fitted under the cable glands or blanking plugs.

For use in explosive dust atmospheres, a minimum ingress protection rating of IP6X must be maintained.

The BEx sounder range can be supplied with the following types of adapters:

- M20 to ½" NPT
- M20 to ¾" NPT
- M20 to M25

It is important to note that stopping plugs cannot be fitted onto adapters, only directly onto the M20 entries. Any other adapters used must be suitably rated and ATEX / IECEx & UKEx certified adapters.

9) Earthing

DC sounder units must be connected to an earth. The units are provided with internal and external earth terminals which are both located on the terminal chamber section of the unit.

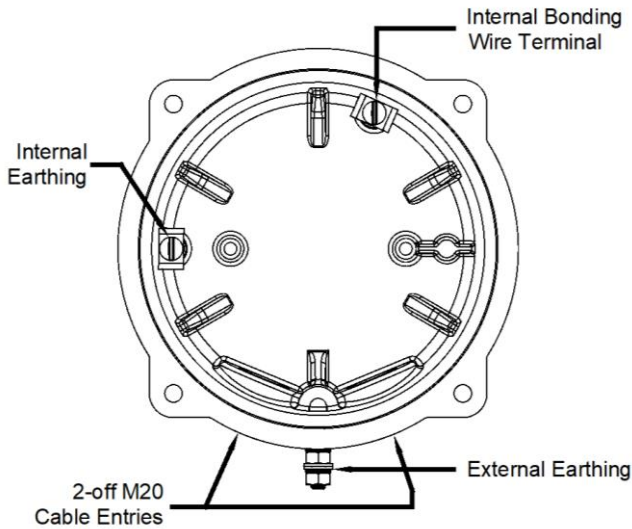

Fig. 3 Internal View of Cover

When using the internal earth terminal ensure that the stainless steel M4 flat washer is between the incoming earth wire and the enclosure.

Internal earthing connections should be made to the Internal Earth terminal in the base of the housing using a ring crimp terminal to secure the earth conductor under the earth clamp. The earth conductor should be at least equal in size and rating to the incoming power conductors. Tighten M4 Earth screw to 1Nm.

External earthing connections should be made to the M5 earth stud, using a ring crimp terminal to secure the earth conductor to the earth stud. The external earth conductor should be at least 4mm² in size. Tighten the Earth nut to 3Nm. Please firmly tighten the external grounding terminal so that the stud does not become loose and lay the ground wire so that it is not caught by twisting and sagging.

10) Cable Connections

Electrical connections are to be made into the terminal blocks on the PCBA located in the flameproof enclosure. See section 7 of this manual for access to the flameproof enclosure.

Wires having a cross sectional area between 0.5 mm² to 2.5mm² can be connected to each terminal way. If an input and output wire is required the 2-off Live/Neutral or +/- terminals can be used. If fitting 2-off wires to one terminal way the sum of the 2-off wires must be a maximum cross sectional area of 2.5mm². Strip wires to 8mm. Wires may also be fitted using ferrules. Terminal screws need to be tightened down with a tightening torque of 0.45 Nm / 5 Lb-in. When connecting wires to the terminals great care should be taken to dress the wires so that when the cover is inserted into the chamber the wires do not exert excess pressure on the terminal blocks. This is particularly important when using cables with large cross sectional areas such as 2.5mm².

11) DC Wiring

A 4-way terminal block is provided on the DC Sounder. There are 1-off +ve, 1-off -ve, 1-off stage 2 and 1-off stage 3 terminals in total.

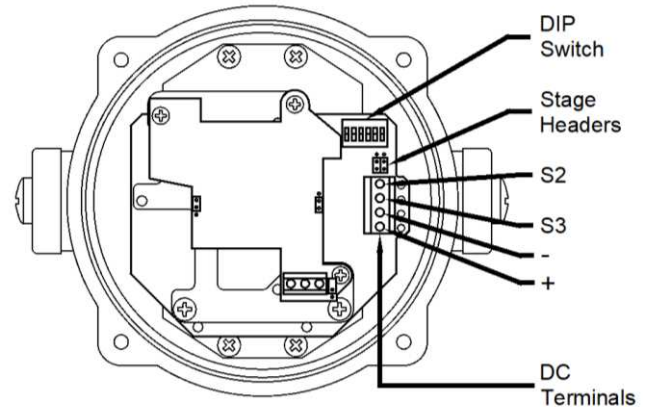

Fig. 4 S110 DC Terminals

Refer to D210-06-651 for schematic diagram.

11.1. Stage Switching Polarity (DC Units)

The BExS110D DC sounders have the facility to use either +ve or -ve switching to change the tone to the second and third stages. Negative switching is the default setting. For -ve switching connect the two headers on the pcb to the left-hand (marked -ve) and centre pins. For +ve switching connect the headers to the right hand (marked +ve) and the centre pins. (Refer to Fig. 5)

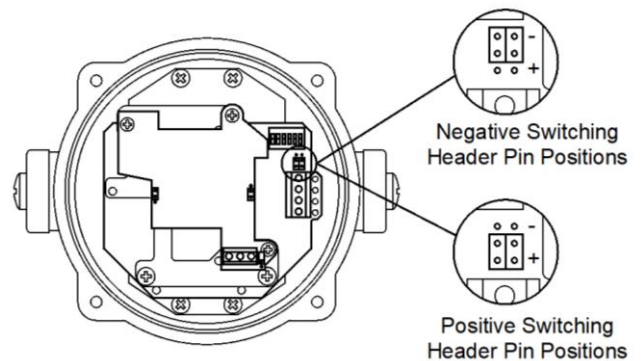

Fig. 5 Stage Switching Polarity

Refer to D210-06-651 for schematic diagram.

11.2. Line Monitoring

On BExS110D DC units, dc reverse line monitoring can be used if required. All DC sounders have a blocking diode fitted in their supply input lines. An end of line monitoring diode or an end of line monitoring resistor can be connected across the +ve and -ve terminals. If an end of line resistor is used it must have a minimum resistance value of $3k3\Omega$ and a minimum power rating of 0.5 watts or a minimum resistance value of 500Ω and a minimum power rating of 2 watts.

The resistor must be connected directly across the +ve and -ve terminals as shown in the following drawing. The resistor leads should be kept as short as possible.

SIL2 line monitoring module product version: see section 22 for standard default values and product coding. See document D210-06-651 for associated wiring diagram.

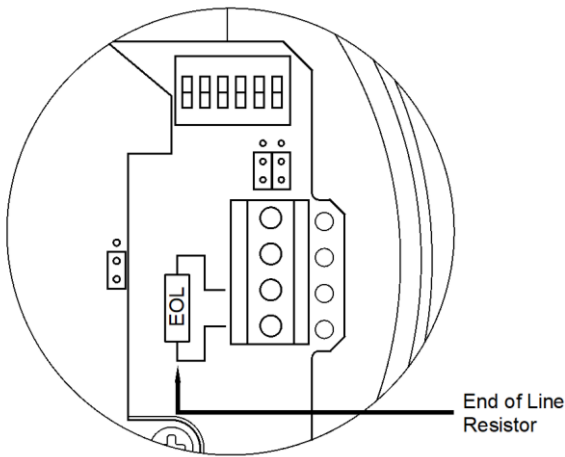

Fig. 6 End of Line Resistor Placement

Note that the maximum forward polarity monitoring voltage is 6V. A monitoring voltage greater than 6V may activate the alarm horn sounder and the 2nd or 3rd stages.

12) Tone Settings

BExS110D-SIL sounders need to be set to one off the SIL 2 approved tones to work correctly with the automated sounder check on pattern generation and signal output checks.

Default =
Tone 1
0 0 0 0 0 0

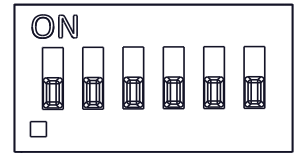

(ON = 1, OFF = 0)

Figure 7: DIP switch configuration

Refer to D210-95-651-IS Tone Table for tone selection.

Table 2 below is a summary of DC: D210-06-651 wiring options.

12.1. Volume Control (None)

BExS110D-SIL sounder has no volume control, as the unit is monitoring its output the volume cannot be adjusted.

13) Maintenance, Overhaul & Repair

Maintenance, repair and overhaul of the equipment should only be carried out by suitably qualified personnel in accordance with the current relevant standards:

EN60079-19 Explosive atmospheres - Equipment repair, overhaul and reclamation
IEC60079-19

EN 60079-17 Explosive atmospheres - Electrical installations inspection and maintenance
IEC60079-17

The acoustic horn is made out of ABS plastic, therefore to avoid a possible ELECTROSTATIC CHARGE the unit must only be cleaned with a damp cloth.

Units must not be opened while an explosive atmosphere is present.

If opening the unit during maintenance operations a clean environment must be maintained and any dust layer removed prior to opening the unit.

Config.	Voltage	Configuration Description	Features	Product Option Identifier
1a	DC	Single Stage Configuration	<ul style="list-style-type: none"> Line monitoring Negative Switching 	1
1b	DC	Two or Three Stage Configuration	<ul style="list-style-type: none"> Common Positive Negative Switching 	1
2	DC	Two or Three Stage Configuration	<ul style="list-style-type: none"> Common Negative Customer to Set Header Pins to Positive Switching 	1

Table 2: Summary of Wiring Options. See Document D210-06-651 for DC Schematic Diagrams.

14) SIL 2 Instruction/Safety Manual

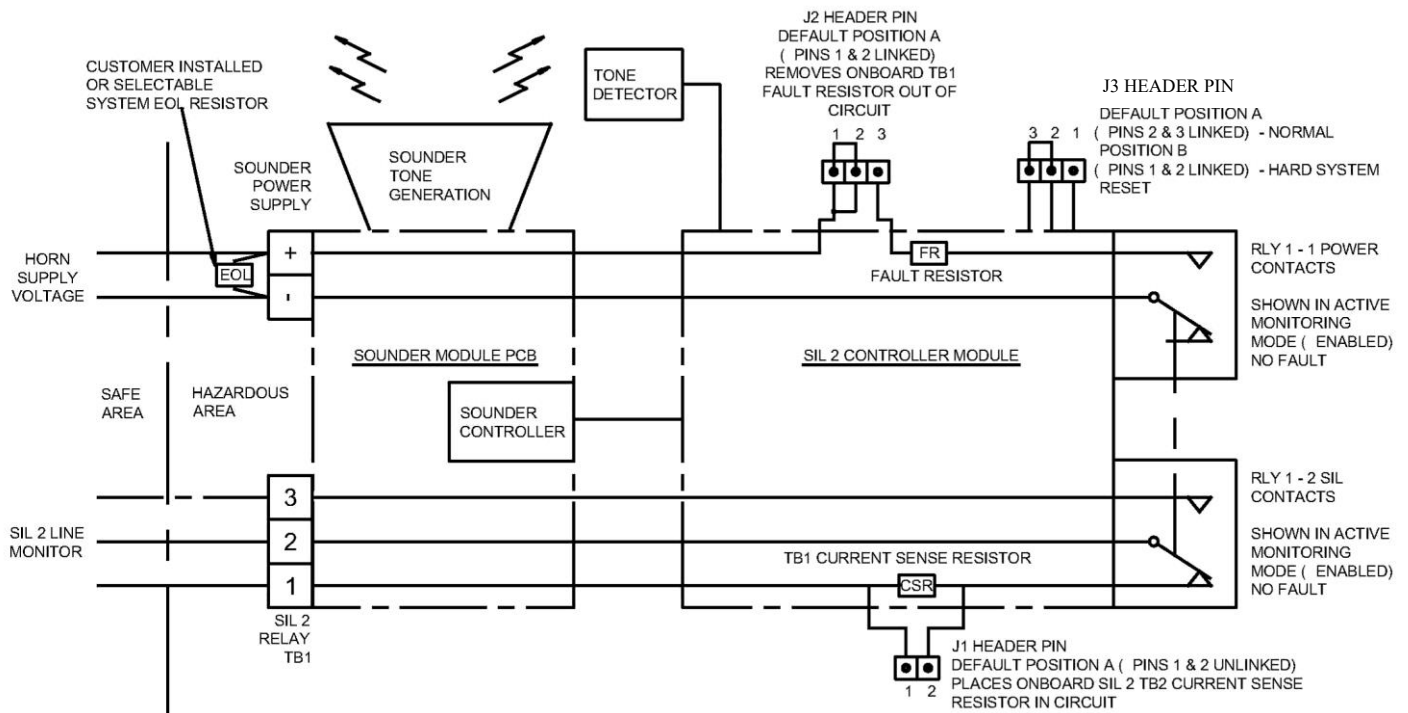

Figure 8 - The SIL 2 Module monitors the Sounder and interfaces to the customer plant.

Warning – To maintain the integrity of the SIL 2 units the system must be installed, commissioned and used within the parameters outlined in this manual. Failure to comply could result in an unintended unit operation or function.

Warning – The unit must be powered in either Standby or Active modes to comply with the SIL 2 approval requirement. If the power is disrupted the unit must be allowed to go through the commissioning cycle to reset. Failure to complete the commissioning cycle and continued disruption in the power supply will generate a fault state which will require the sounder to be reset (see section 18-4).

Warning – Only the alarm tones specified in section 17 may be selected for use in SIL2 compliant systems.

SIL 2 System Description

The SIL 2 module monitors the function of the device and provides feedback to the control panel. A fault condition can be communicated by two methods:

- 4 wire installation can be seen as per section 18-1. A SIL 2 system wiring for fault detection in standby and active mode with independent fault contacts.
- 2 wire installation can be seen as per section 18-2. A SIL 2 system by the introduction to the monitoring circuit and linking in an end of line resistor can only register the fault in standby mode.

15) SIL 2 System Terms and Function

The SIL 2 Sounder Unit Monitors

- Standby mode and Active mode
- Health status of power supply
- Sounder correct function and tone pattern

The SIL 2 sounder operates as part of a SIL 2 system. The sounder will after commissioning remain powered in **Standby mode** (reverse polarity) until the sounder is required to operate. When the signaling device is required to operate the polarity is changed to normal supply and the sounder will go into **Active mode** where it will start to sound the correct tone. When periodically testing the system and sounders operation is put into **Active mode**.

The system panel or PLC will control whether the system is in either of the main two operational modes.

Standby Mode – This is where the power supply polarity is reversed so negative (-ve) is feed to the positive (+) sounder terminal and positive (+) is feed to the negative (-ve) sounder terminal.

In Standby mode the sounder will not sound the tone but the SIL 2 unit is monitoring power supply and is set-up ready to go to Active (alarm) mode.

Power relay RLY1-1 will be open whilst SIL 2 relay RLY1-2 will be closed contact between terminals 1 & 2.

If power is disrupted the SIL 2 unit will go into **Fault mode**, in fault mode the Power relay RLY1-1 will close whilst SIL 2 relay RLY1-2 will become open circuit between terminals 1 & 2.

Active Mode – This is where the power is in normal polarity, positive (+) supplied to the positive (+) sounder terminal and negative (-ve) is supplied to the negative (-ve) sounder terminal.

In Active mode the alarm horn sounder will output the selected alarm tone. The SIL 2 module checks for the correct alarm tone output and the functionality of the alarm tone signal generation process.

Power relay RLY1-1 will be open whilst SIL 2 relay RLY1-2 will be closed contact between terminals 1 & 2.

The SIL 2 unit will also check for signal polarity.

If a fault is found the SIL 2 unit will go into **Fault mode**.

If power is disrupted the SIL 2 unit will go into **Fault mode**, in fault mode the Power relay RLY1-1 will close whilst SIL 2 relay RLY1-2 will become open be circuit between terminals 1 & 2.

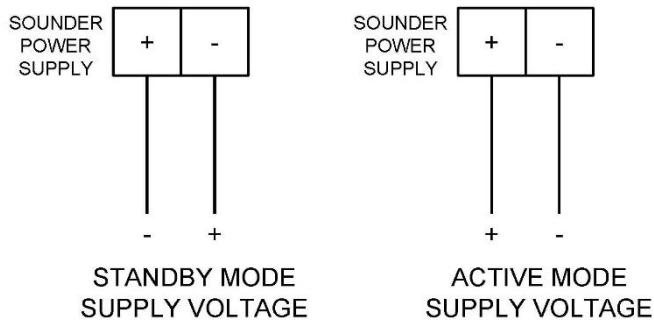

Fault modes - The fault modes listed 15-1 & 15-2 below will make the SIL 2 unit change the state for relays RLY1-1 and RLY1-2.

In fault mode the Power relay RLY1-1 will close whilst SIL 2 relay RLY1-2 will become open circuit between terminals 1 & 2.

15-1 Sounder Failure

- Tone Failure – No Tone detected
- Sounder Controller failure – No tone generation pulse detected
- Tone Rate Failure – Regular tone cycle erratic

15-2 Power Failure / SIL 2 Failure

- SIL 2 Controller failure – Internal function and system checking flags fault
- Rapid Power cycling – System indicates power instability
- Total Power Failure

It is possible to reset these faults if they were transitory.

Resetting Failure (by power cycling) - It is possible that the SIL 2 unit can be reset by powering the unit off for a period greater than 20 seconds. On restarting the unit and running through the commissioning cycle the fault may clear.

Resetting Failure (by Hard Reset) - It is possible that the SIL 2 unit can be reset by hard resetting the unit using the reset jumper within the unit (see section 18-4) on hard resetting. On restarting the unit and running through the commissioning cycle, the fault may clear. It is necessary to run the test function cycle again to see if the fault is still evident.

If the hard reset process does not correct the latched fault the alarm horn sounder may require further investigation, please contact your local E2S representative.

Commissioning System - Functional start-up of System (Normally in reverse polarity mode)

When Commissioning system the power must not be disrupted to the SIL 2 Unit within the unit's initialization cycle which is **5 seconds**.

Once past this period the SIL 2 system is fully operational and will be in monitoring the sounder and power in Standby mode.

The relay RLY1-2 on the SIL 2 unit will only remain open for a maximum of 1 second on commissioning start-up. RLY1-2 will subsequently close contacts 1 & 2 indicating healthy operation. Contact 1 & 2 will only remain open in the event of a fault or a loss of power.

System Testing (Active Mode normal polarity)

The SIL 2 system will remain monitoring the power in standby mode until the polarity is changed to normal mode to enable an active system for sounder functional testing.

Important: - The polarity must be held in active mode for a period in excess of **15 seconds** to ensure a full system check is performed.

Once the test period has been completed the unit can be switched back to standby mode by reversing the polarity.

If no faults have been found during the test the relays will remain in steady state.

The SIL 2 unit will continue to monitor the power and module function.

Important: - The automated test cycle **must** be undertaken on at least a weekly basis to maintain the SIL 2 units reliability.

System Activation (Active Mode normal polarity)

The SIL 2 system will remain monitoring the power in standby mode until the polarity is changed to Active mode to enable an active system for sounder to function as a warning signaling device.

Important: :- The polarity must be held in active mode for a period in excess of 15 seconds to ensure a full system check is performed whilst in alarm mode, although it is expected that during a system activation this period will be significantly greater.

Note :- The fault indication signal on TB1 can take up to 50 milliseconds to indicate system fault.

16) SIL 2 Wiring configuration and Sounder set-up

J3 Header – Hard Reset
Shown in factory default position A (see section 18-4), set to Normal operation

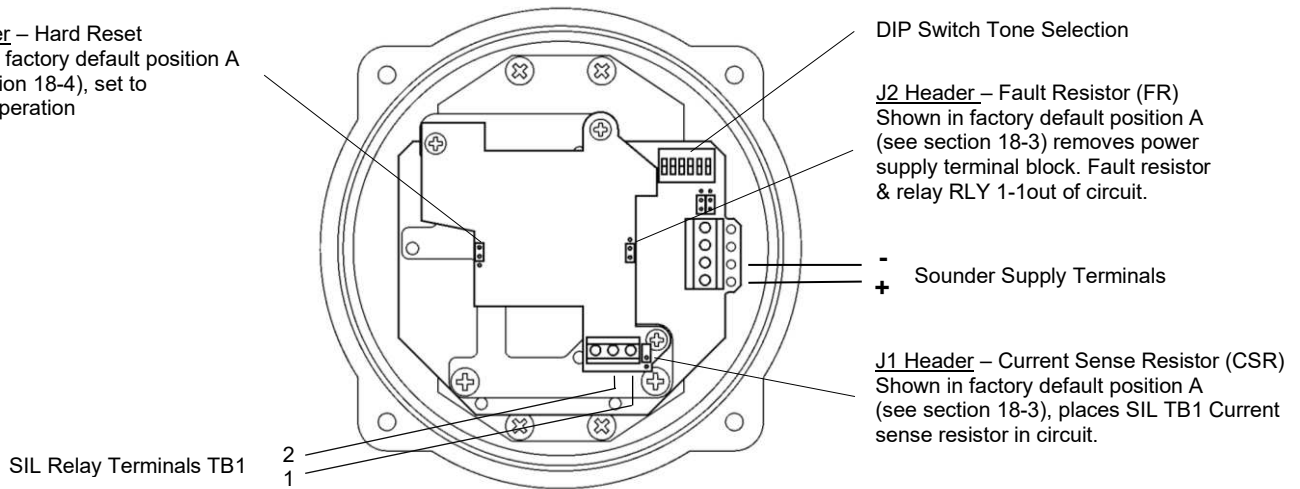

Figure 9 – Terminals and header pins for sounder

Power & Communication with the system control panel can be configured in two ways: - Although it is **highly** recommended that the unit is wired as stated in this section 18-1 as a 4 – Wire System.

17) SIL 2 APPROVED TONE SELECTION

BExS110D-SIL sounders need to be set to one off the SIL 2 approved tones to work correctly with the automated sounder check on pattern generation and signal output checks.

Important: - Only tones use tones that are stated as SIL 2 approved for the SIL 2 application. Ensure that the unit is set to one of these tones see in Tone Table (D210-95-651-IS).

As factory default the sounder should be set to Stage 1 (Dip switch 000000).

18-1) SIL 2 system wiring for fault detection in standby and active mode – 4 wire installation (Recommended)

The customer is required to wire into both the sounder power supply terminals block and also the SIL 2 Relay terminals TB1

The power supply terminals only need to have the supply power connected. This will be reverse polarity for monitoring mode and normal polarity for active mode. There is no need to fit an EOL resistor on the power supply terminal block as the TB1 is configured to raise a fault alarm in any situation.

Terminal block TB1 is the output from the SIL 2 monitoring relay. Relay RLY 1-2 provides a closed circuit between TB1 terminals 1 & 2 whilst powered. On detection of a fault event this will become open circuit.

The fault will be seen via the SIL 2 TB1 terminals as soon as the fault occurs in either Active or Standby modes.

When no fault is detected the circuit to the SIL 2 TB1 terminals 1 & 2 will include a factory fitted 3.3K Ohm current sense resistor (CSR) in series. When the circuit is driven with 24Vdc the detection current seen is ~7.3mA @ 24V.

The only other fault mode is if the cable goes short circuit where a short will be seen by the panel.

Option: Should the fault event output of RLY1-2 be required to operate as a switch, header J1 can be set to link pins 1 & 2 (see figure 10) thereby removing the 3.3k Ohm current sense resistor (CSR) from the circuit.

Note: a cable short circuit will not be detectable in this configuration.

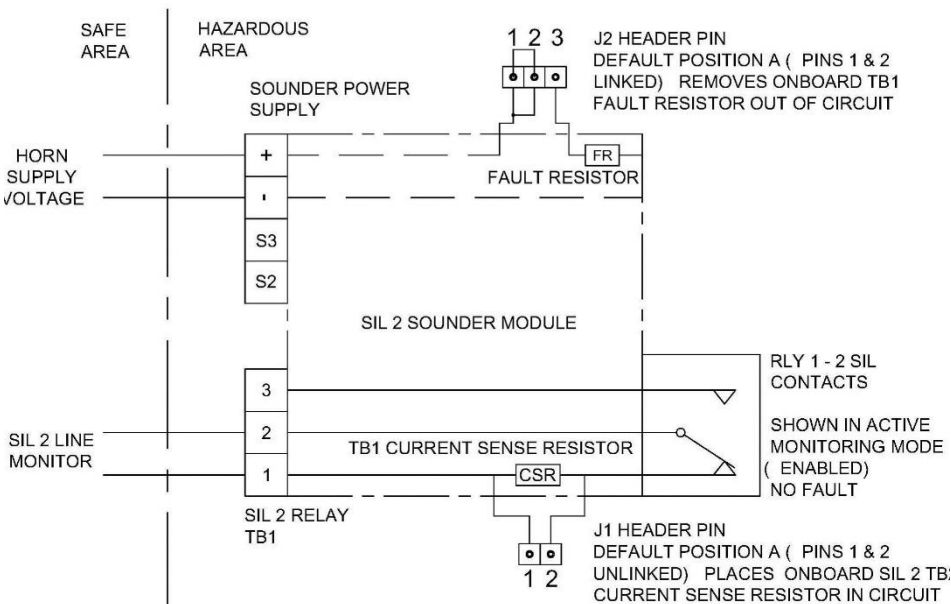

For one unit only:

Sounder power supply terminal block	Current drawn (mA)
Active Mode	190mA
Standby Mode	25mA

SIL2 TB1 Current Sense Resistor value	Current drawn (mA)
3.3kΩ	7.2mA

On fault mode, current drops to 0 as circuit goes open.

Figure 10 - Schematic of SIL 2 system wiring for fault detection in standby and active mode – 4 wire installation.

If multiple SIL 2 alarm horn sounders are to be cabled in series the monitoring connections differ from that of a single alarm horn sounder. For more information see manual D197-00-651-IS available from the E2S website.

18-2) SIL 2 system wiring for fault detection in standby mode only – 2 wire installation

Cabling is required to the positive '+' and negative '-' power input terminals only. Monitoring will occur in standby mode only whilst power supply polarity is reversed. An EOL resistor may be added during installation or can be factory fitted. See Table 3 for EOL resistor value guidance.

The SIL2 monitoring module contains a factory fitted Power Supply Fault Resistor 2.2K Ohm (FR). When a fault is detected the Fault Resistor will activated. The total measurable resistance of the EOL resistor and Fault Resistor across the power terminals which already has customer EOL resistor (2.2kΩ) in place. This will result in a total fault detection current of 41.8mA @ 24V but can only be detected when unit is in Standby Mode.

Important: - The 2 wire configuration will not warn of a fault whilst in Active mode. A fault will only be detectable in standby mode when power supply polarity is reversed.

Important: - The 2-wire configuration requires the J2 header pin to be set to position B (see figure 13). Factory default position is A.

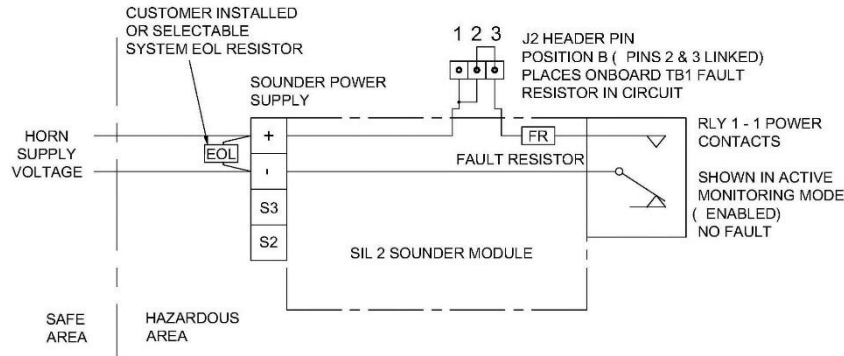

Figure 11 - Schematic of SIL 2 system wiring for fault detection in standby mode only – 2 wire installation

To evaluate the total current drawn from the SIL 2 unit, use the equation below.

$$I_{\text{(Total Current drawn)}} = I_{\text{FR}} \text{ (Current drawn from Fault Resistor)} + I_{\text{EOL}} \text{ (Current drawn from Customer EOL resistor)} + I_{\text{SIL}} \text{ (Current drawn from SIL board)}$$

In standby mode, where there is no fault, RLY 1-1 is open. This means the voltage only passes through the customer EOL resistor and the current drawn from the SIL 2 board is 25mA. Therefore, the equation for a No Fault scenario is then:

$$I_{\text{NF}} \text{ (Standby Mode, Total Current drawn - No Fault)} = I_{\text{FR}} \text{ (0mA)} + I_{\text{EOL}} \text{ (See table 3)} + I_{\text{SIL}} \text{ (25mA)}$$

In standby mode, where there is a fault, the circuit is closed. This means the voltage passes through both the customer EOL resistor and current sense resistor and the current drawn from the SIL 2 board is 20mA. The customer must first calculate the resistance of the two resistors in parallel before applying the currents to the equation. The equation for a Fault scenario is then:

$$I_{\text{F}} \text{ (Standby Mode, Total Current drawn - Fault)} = I_{\text{TR}} \text{ (Total Resistance when EOL & FR in parallel)} + I_{\text{SIL}} \text{ (20mA)}$$

Standby Mode	Power Supply Fault Resistor		Customer EOL Resistor		(Fault Mode Only)		Current drawn from SIL Board	Total current drawn
	Resistor Value	Current drawn (I_{FR})	Resistor Value	Current drawn (I_{EOL})	Total resistance	Current drawn (I_{TR})		
No Fault	2.2 kΩ	0 mA	2.2 kΩ	10.9 mA	-	-	25 mA	35.9 mA
Fault		-		-	1.1 kΩ	21.8 mA	20 mA	41.8 mA
No Fault	1.0 kΩ	0 mA	1.0 kΩ	24.0 mA	-	-	25 mA	49.0 mA
Fault		-		-	500 Ω	48.0 mA	20 mA	68.0 mA
No Fault	2.2 kΩ	0 mA	3.3 kΩ	7.3 mA	-	-	25 mA	32.3 mA
Fault		-		-	1.3 kΩ	18.2 mA	20 mA	38.2 mA
No Fault	1.8 kΩ	0 mA	3.9 kΩ	6.2 mA	-	-	25 mA	31.2 mA
Fault		-		-	1.2 kΩ	19.5 mA	20 mA	39.5 mA
No Fault	1.8 kΩ	0 mA	4.7 kΩ	5.1 mA	-	-	25 mA	30.1 mA
Fault		-		-	1.3 kΩ	18.4 mA	20 mA	38.4 mA
No Fault	2.2 kΩ	0 mA	4.7 kΩ	5.1 mA	-	-	25 mA	30.1 mA
Fault		-		-	1.5 kΩ	16.0 mA	20 mA	36.0 mA

Table 3: Resistor combinations and the currents drawn when no faults and faults occur

If multiple SIL 2 alarm horn sounders are to be cabled in series the monitoring connections differ from that of a single alarm horn sounder. For more information see manual D197-00-651-IS available from the E2S website.

18-3) Header Pins Settings

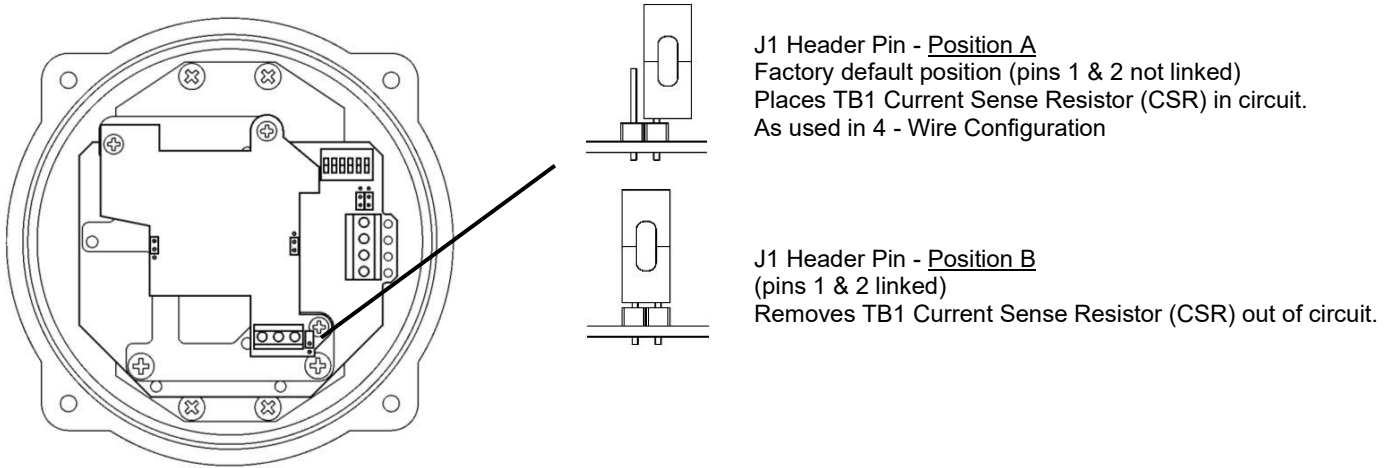

Figure 12: J1 Header pin positions – Current Sense Resistor (CSR)

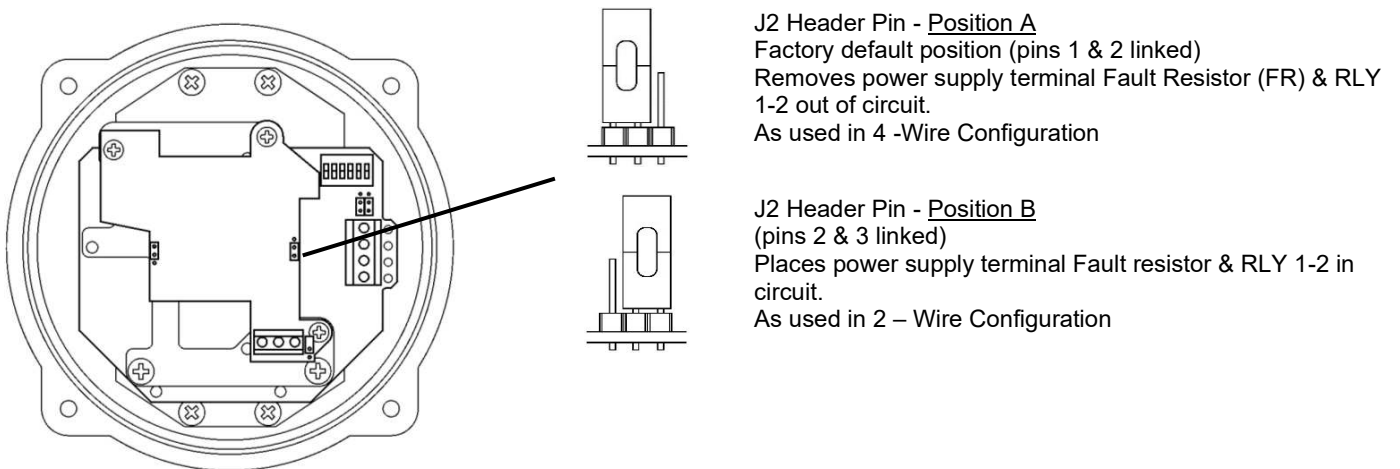

Figure 13: J2 Header pin positions – Fault Resistor (FR)

18-4) SIL 2 Hard Reset Function

Power down the unit completely for a minimum of 30 seconds. Move the hard reset header pin (Jumper J3) to reset position B shown. Then power the unit for a minimum of 5 seconds. Power down the unit for 30 seconds and then move the header pin back to Position A.

The unit has now been reset.

If the hard reset process does not correct the latched fault the alarm horn sounder may require further investigation, please contact your local E2S representative.

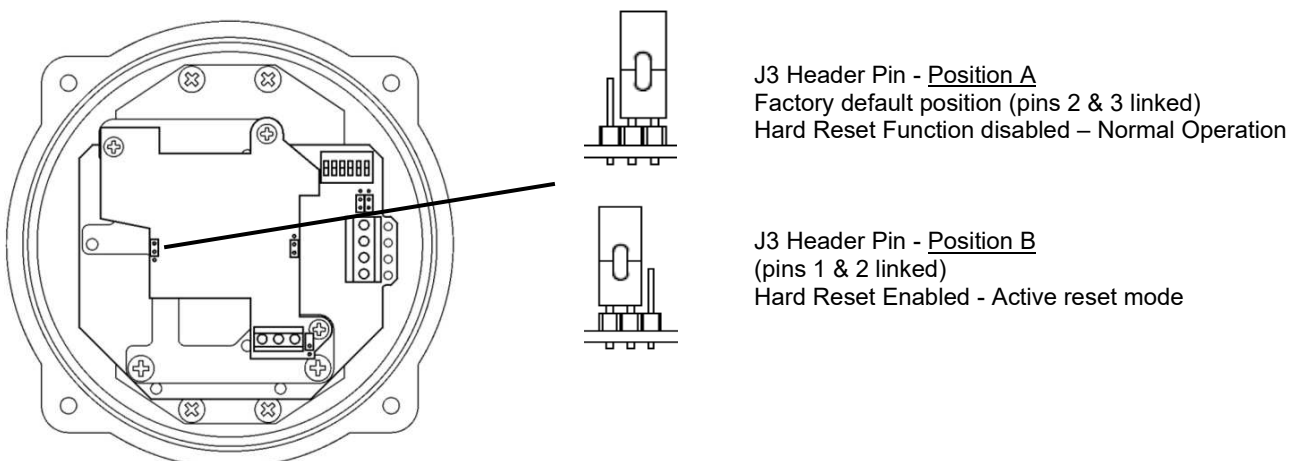

Figure 14: J3 Header pin positions – Hard Reset Function

19) SIL 2 Specific Unit Mounting Requirements

The sounder should be mounted no closer than 5m from a sounder source of similar SPL output. This is to ensure false tone activation does not occur when the unit is monitoring the tone pulse duration and tone failure.

20) SIL 2 Reliability Data

Reliability and Functional safety IEC/EN61508 which has been assessed and is considered suitable for use in low demand safety function:

1. Random Hardware Failures and Architectural constraints (route 1_H)
2. As an unvoted item (i.e. hardware fault tolerance of 0) at SIL 2

The product was assessed against failure modes:

- Failure respond to an input with a correct tone.
- Failure to respond to an input even with an alternative tone.
- Spurious sound output despite no input.

BExS110D-SIL (Failure to Sound)

Integrity in respect of failure to release	SIL 2
Total Failure rate	0.304 pmh
"hazardous" failure rate (revealed)	0.233 pmh
"hazardous" failure rate (unrevealed)	0.017 pmh
"safe" failure rate (revealed)	0
"safe" failure rate (unrevealed)	0
Diagnostic Coverage	93%
System type	B
Hardware Fault Tolerance	0
Safe Failure Fraction	>93%
PFD (hazardous failure)	9.4 x 10 ⁻⁵
Proof Test Interval	Up to 1 week

BExS110D-SIL (Failure to Sound or Incorrect tone)

Integrity in respect of failure to release	SIL 2
Total Failure rate	0.304 pmh
"hazardous" failure rate (revealed)	0.235 pmh
"hazardous" failure rate (unrevealed)	0.005 pmh
"safe" failure rate (revealed)	0.01
"safe" failure rate (unrevealed)	0
Diagnostic Coverage	98%
System type	B
Hardware Fault Tolerance	0
Safe Failure Fraction	>98%
PFD (hazardous failure)	2.0 x 10 ⁻⁵
Proof Test Interval	Up to 1 week

Table 4: SIL 2 Failure Rate

21) Synchronised Operation

All BExS110D-SIL alarm horn sounders connected to the same power supply and set to the same alarm tone will provide a synchronised output when activated.

22) Product Coding for Fault Resistor and Customer EOL Resistor

The customer is able to identify the resistor values chosen on purchase from the product code.

This is represented by the last three characters:

BExS110DFDC024AB1S1R **AFZ**

- The first A character denotes the value of the Fault Resistor (FR) Default value is 2.2 kΩ (Code = A) unless an alternative value is requested when ordering.
- The second F character denotes the value of the Current Sense Resistor (CSR) Default value is 3.3 kΩ (Code = F) unless an alternative value is requested when ordering.
- The third Z character denotes the value of the unit End Of Line Resistor (EOL) By default no EOL is fitted (Code = Z) A factory fitted EOL resistor can be specified when ordering.

The values of resistors available are shown in table 5 below.

Code	Resistor Value
A	2.2 kΩ
B	1.0 kΩ
C	1.5 kΩ
D	1.8 kΩ
E	2.7 kΩ
F	3.3 kΩ
G	3.9 kΩ
H	4.7 kΩ
J	5.6 kΩ
K	6.8 kΩ
L	8.2 kΩ
M	11 kΩ
Z	None Fitted

Table 5: Resistor Value code

Three digit resistor coding as follows.

BExS110DFDC024AB1S1R **-AFZ**

Example of a custom requirement resistor coding:

BExS110DFDC024AB1S1R **-GEF**

Where the (FR) Fault Resistor is (G = 3.9 kΩ)
(CSR) Current Sense Resistor is (E = 2.7 kΩ)
(EOL) End Of Line resistor is (F = 3.3 kΩ)

Two digit resistor coding on other units.

BExS110DFDC024AB1S1R **-AZ**

Where the (FR) Fault Resistor is (A = 2.2 kΩ)
(EOL) End Of Line resistor is (Z = none fitted)







Note: Customers who have previously acquired BExS110D-SIL sounders with the two-character resistor code system (**-XX**) may continue to use their E2S product code reference to repeat purchase orders. In the two-character code, the first character denotes the value of the Fault Resistor (FR) and the second character denotes the value of the EOL resistor.

Note: To utilise the full monitoring functionality the 4-wire configuration is recommended. An EOL resistor is not required for this configuration.

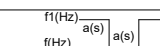
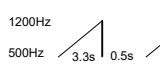
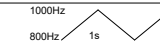
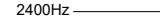
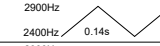
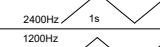
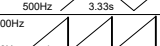
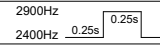
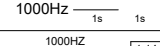
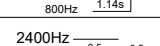
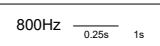
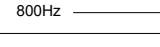
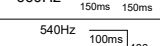
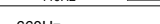
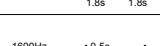
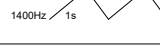
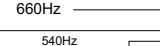
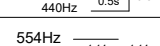
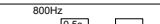
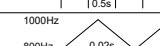
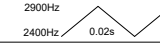
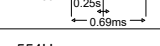
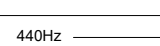
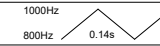
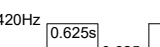
The alternative 2-wire configuration requires an EOL resistor to be fitted. The EOL resistor can be specified during ordering and factory fitted or selected and fitted during the alarm horn sounder installation.

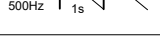
See section 11 for EOL resistor location and wattage requirements. E2S recommends a value of 2.2K Ohm. If an alternative value is required, please see section 18-2.

Both the (FR) Fault Resistor and (CSR) Current Sense Resistor are factory fitted and cannot be user replaced.

Stage 1 Set DIP SW 1 Tone No.	SIL 2 Approved Tone	Tone Description	Tone Visual	Stage 1 DIP SW 1 Settings 1 2 3 4 5 6	Stage 2	Stage 3
1	Yes	Continuous 1000Hz Toxic Gas Alarm	1000Hz 	0 0 0 0 0	1	11
2	Yes	Alternating 800/1000Hz at 0.25s Intervals		1 0 0 0 0	17	5
3	Yes	Slow Whoop 500/1200Hz at 0.3Hz with 0.5s gap repeated		0 1 0 0 0	2	5
4	Yes	Sweeping 800/1000Hz at 1Hz		1 1 0 0 0	6	5
5	Yes	Continuous at 2400Hz	2400Hz 	0 0 1 0 0	3	27
6	No	Sweeping 2400/2900Hz at 7Hz		1 0 1 0 0	7	5
7	Yes	Sweeping 2400/2900Hz at 1Hz		0 1 1 0 0	10	5
8	Yes	Siren 500/1200/500Hz at 0.3Hz		1 1 1 0 0	2	5
9	No	Sawtooth 1200/500Hz at 1Hz		0 0 0 1 0	15	2
10	Yes	Alternating 2400/2900Hz at 2Hz		1 0 0 1 0	7	5
11	Yes	Intermittent 1000Hz at 0.5Hz General Alarm	1000Hz 	0 1 0 1 0	31	1
12	Yes	Alternating 800/1000Hz at 0.875Hz		1 1 0 1 0	4	5
13	Yes	Intermittent 2400Hz at 1Hz	2400Hz 	0 0 1 1 0	15	5
14	Yes	Intermittent 800Hz 0.25s on 1s off	800Hz 	1 0 1 1 0	4	5
15	Yes	Continuous at 800Hz	800Hz 	0 1 1 1 0	2	5
16	No	Intermittent 660Hz 150mS on, 150mS off	660Hz 	1 1 1 1 0	18	5
17	Yes	Alternating 544Hz (100mS)/440Hz(400mS)		0 0 0 0 1 0	2	27
18	Yes	Intermittent 660Hz 1.8s on, 1.8s off	660Hz 	1 0 0 0 1 0	2	5
19	Yes	1400Hz to 1600Hz sweep up over 1s - 1600Hz to 1400Hz sweep down over 0.5s		0 1 0 0 1 0	2	5
20	Yes	Continuous 660Hz	660Hz 	1 1 0 0 1 0	2	5
21	Yes	Alternating 554/440Hz at 1Hz		0 0 1 0 1 0	2	5
22	No	Intermittent 554Hz at 0.875Hz	554Hz 	1 0 1 0 1 0	2	5
23	Yes	800Hz pulsing at 2Hz	800Hz 	0 1 1 0 1 0	6	5
24	No	Sweeping 800/1000Hz at 50Hz		1 1 1 0 1 0	29	5
25	No	Sweeping 2400/2900Hz at 50Hz		0 0 0 1 1 0	29	5
26	No	Simulated Bell Sound		1 0 0 1 1 0	2	1
27	Yes	Continuous 554Hz	554Hz 	0 1 0 1 1 0	26	5
28	Yes	Continuous 440Hz	440Hz 	1 1 0 1 1 0	2	5
29	No	Sweeping 800/1000Hz at 7Hz		0 0 1 1 1 0	7	5
30	No	420Hz repeating 0.625s on, 0.625s off Australian Alert Signal		1 0 1 1 1 0	32	5
31	Yes	1200/500Hz at 1Hz Prepare to Abandon Platform		0 1 1 1 1 0	11	1
32	No	Sweeping 500/1200Hz 3.75s on, 0.25s off 15Hz		0 0 0 0 0 1	26	1

1	2	3	4	5	6	7	8	9	10
							ISSUE	MOD No.	REASON - INITIAL - DATE
							1		INTRODUCTION MA 16-01-2023

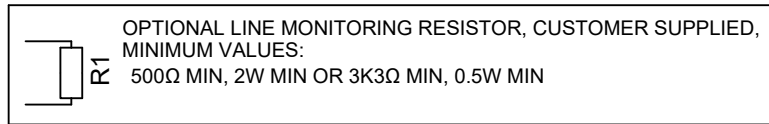

Single Stage Configuration	Config.: 1a	Two or Three Stage Configuration	Config.: 1b	Two or Three Stage Configuration	Config.: 2
----------------------------	-------------	----------------------------------	-------------	----------------------------------	------------

Line Monitoring Header pins set to negative switching (default)	Line Monitoring Common Positive Header pins set to negative switching (default)	Line Monitoring Common Negative Set header pins to positive switching
--	---	---

Stage 1: Apply Power to Stage 1 +ve & Stage 1 -ve For full 4-Wire SIL 2 Connection Monitor SIL 2 +ve and SIL 2 -ve Terminals 1 & 2 in RLY1-2	Stage 1: Apply Power to +ve & -ve Stage 2: Apply Power to +ve & -ve, Connect Stage 2 to -ve Stage 3: Apply Power to +ve & -ve, Connect Stage 3 to -ve For full 4-Wire SIL 2 Connection Monitor SIL 2 +ve and SIL 2 -ve Terminals 1 & 2 in RLY1-2	Stage 1: Apply Power to +ve & -ve Stage 2: Apply Power to +ve & -ve, Connect Stage 2 to +ve Stage 3: Apply Power to +ve & -ve, Connect Stage 3 to +ve For full 4-Wire SIL 2 Connection Monitor SIL 2 +ve and SIL 2 -ve Terminals 1 & 2 in RLY1-2
--	--	--

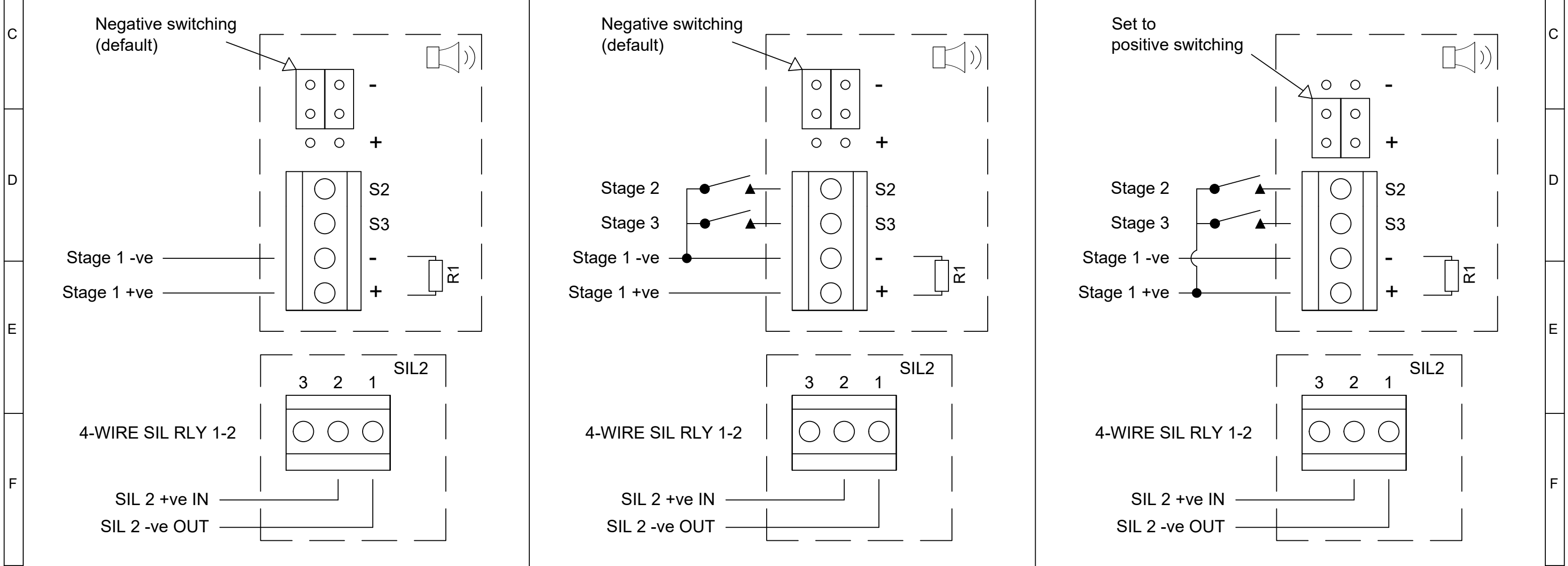

DRAWING TO BS8888:2000 GEOMETRIC TOLERANCES TO ISO1101:1983 LINEAR DIMENSIONAL TOLS ANGULAR DIMENSIONAL TOLS	DRAWN M.ABALOS	DATE 16-01-2023	SURFACE FINISH	WEIGHT (Kg)	THIS DRAWING AND ANY INFORMATION OR DESCRIPTIVE MATTER THEREIN IS COMMUNICATED IN CONFIDENCE AND IS THE COPYRIGHT PROPERTY OF EUROPEAN SAFETY SYSTEMS LTD. NEITHER THE WHOLE OR ANY EXTRACT MAY BE DISCLOSED, LOANED, COPIED OR USED FOR MANUFACTURING OR TENDERING PURPOSES WITHOUT THEIR WRITTEN CONSENT.	 EUROPEAN SAFETY SYSTEMS LTD IMPRESS HOUSE MANSELL ROAD ACTON LONDON W3 7QH WWW.E2S.COM	ALL DIMENSIONS IN MM IF IN DOUBT, ASK - DO NOT SCALE		A3
	CHECKED R.N.POTTS	DATE 16-01-2023	MATERIAL	TITLE BExS110D-S & BExS120D-S DC SIL2 SOUNDER WIRING DIAGRAMS					
	STANDARDS BEx	APPROVED R.N.POTTS	DATE 16-01-2023	ALTERNATIVE MATERIAL			SCALE NTS	SHEET 1 OF 1	DRAWING NUMBER D210-06-651

EU Declaration of Conformity



Manufacturer: European Safety Systems Ltd.
Impress House, Mansell Road, Acton
London, W3 7QH
United Kingdom

Authorised Representative: E2S Warnsignaltechnik UG
Charlottenstrasse 45-51
72764 Reutlingen
Germany

Equipment Type: Electronic Sounders, Types BExS110D(-R)(-SIL), BExS120D(-R),
Electronic Sounders, Types BExS110E(-R), BExS120E(-R),
Loudspeakers, Types BExL15D(-R), BExL25D(-R),
Loudspeakers, Types BExL15E(-R), BExL25E(-R),
Appello Speech Sounders, Types BExA110(-R),
Sontel, Types BExTS110D(-R),
Hootronic Sounder, Types BExH120D(-R),
Monitored Loudspeaker, Types BExL25GD(-R)

Directive 2014/34/EU: Equipment and Protective Systems for use in Potentially Explosive Atmospheres (ATEX)

Notified Body for EU type Examination (Module B):	Dekra Certification B.V. Notified Body No.: 0344 Meander 1051, 6825 MJ Arnhem, The Netherlands
EU-type Examination Certificate (Module B):	KEMA 99ATEX6312X
Notified Body for Quality Assurance Notification / Conformity to EU-type based on quality assurance of the production process (Module D):	Sira Certification Service Notified Body No.: 2813 CSA Group Netherlands B.V, Utrechtseweg 310, 6812 AR, Arnhem, Netherlands
Quality Assurance Notification (Module D):	SIRA 05 ATEX M342
Provisions fulfilled by the equipment:	II 2G Ex db IIB or IIC T4 Gb II 2G Ex db eb IIB or IIC T4 Gb II 2D Ex tb IIIC T100 °C or T105 °C or T115 °C Db
Standards applied:	EN IEC 60079-0 : 2018 EN 60079-1 : 2014 EN 60079-7 : 2015 + A1 : 2018 EN 60079-31 : 2014

Regulation EU No. 305/2011: Construction Products Regulation (CPR) – BExS110D24DC/BExS120D24DC (tones 2, 3, 9, 15, 16, 17) only

Notified Product Certification Body for Certificate of Constancy of Performance or EC Type Examination Certificate and continuous surveillance, assessment and evaluation of factory production control:	VdS Schadenverhütung GmbH Notified Body No.: 0786 Amsterdamer Str 172-174, 50735 Köln, Germany
Certificate of Constancy of Performance or EC Type Examination Certificate:	0708-CPD-20225
Standards applied:	EN 54-3:2001 + A1:2002

Directive 2014/90/EU: Marine Equipment Directive (MED) – part codes specified below only - BExS110D24DC-M only

Notified Body for EU type Examination (Module B) and Conformity to EU-type based on quality assurance of the production process (Module D):	DNV AS Notified Body No.: 0575 DNV Høvik, Norway
EU-Certificate Type Examination (Module B):	MEDB00001BU
EU Certificate of Conformity for the Quality Assurance System (Module D):	MEDD00000GV
Standards applied:	EN 54-3:2014 incl. A1: 2019 IEC 60092-504: 2016

EU Declaration of Conformity



IEC 60533: 2015

Directive 2014/30/EU: Electromagnetic Compatibility Directive (EMC)

Standards applied:

EN 61000-6-1:2007
EN 61000-6-2:2005
EN 61000-6-3:2007 + A1:2011 + AC: 2012
EN 61000-6-4:2007 + A1: 2011

Directive 2011/65/EU: Restriction of the use of certain hazardous substances in electrical and electronic equipment (RoHS)

The product and all the components contained within it are in accordance with the restriction of the use of hazardous substances in electrical and electronic equipment, including amendment by Directive 2015/863/EU.

Regulation (EC) 1907/2006: Registration, Evaluation, Authorisation and Restriction of Chemicals (REACH)

The product and all the components contained within it are free from substances of very high concern.

Other Standards and Regulations

EN 60529:1991 + A1:2000 + A2:2013. - Degrees of protection provided by enclosures (IP code) – enclosure rated IP66/67

On behalf of European Safety Systems Ltd., I declare that, on the date the equipment accompanied by this declaration is placed on the market, the equipment conforms with all technical and regulatory requirements of the above listed directives, regulations and standards.

This Declaration is issued under the sole responsibility of the manufacturer.

A handwritten signature in black ink, appearing to read 'Martin Streetz'.

Martin Streetz
Quality Assurance Manager

Document No.: DC-001_Issue_P
Date and Place of Issue: London, 28/11/2022



UKCA Declaration of Conformity



Manufacturer: European Safety Systems Ltd.
Impress House, Mansell Road, Acton
London, W3 7QH
United Kingdom

Equipment Type: Electronic Sounders, Types BExS110D(-R)(-SIL), BExS120D(-R),
Electronic Sounders, Types BExS110E(-R), BExS120E(-R),
Loudspeakers, Types BExL15D(-R), BExL25D(-R),
Loudspeakers, Types BExL15E(-R), BExL25E(-R),
Appello Speech Sounders, Types BExA110(-R),
Sontel, Types BExTS110D(-R),
Hootronic Sounder, Types BExH120D(-R),
Monitored Loudspeaker, Types BExL25GD(-R)

Directive UKSI 2016:1107 (as amended by UKSI 2019:696) – Schedule 3A, Part 1 : Product or Protective System Intended for use in Potentially Explosive Atmospheres (UKCA)

Notified Body for UK type Examination (Module B):	UL International (UK) Ltd Notified Body No.: 0843 Unit 1-3 Horizon Kingsland Business Park, Wade Road, Basingstoke, Hampshire RG24 8AH UK
UK-type Examination Certificate (Module B):	UL21UKEX2638X
Notified Body for Quality Assurance Notification / Conformity to EU-type based on quality assurance of the production process (Module D):	Sira Certification Service Notified Body No.: 0518 Rake Lane, Eccleston, Chester CH4 9JN, UK
Quality Assurance Notification (Module D):	CSAE 22UKQAN0046
Provisions fulfilled by the equipment:	II 2G Ex db IIB <i>or</i> IIC T4 Gb II 2G Ex db eb IIB <i>or</i> IIC T4 Gb II 2D Ex tb IIIC T100°C <i>or</i> T105°C <i>or</i> T115° Db IP6X Dust Protection to EN60079-0 / EN60079-31
Standards applied:	EN IEC 60079-0: 2018 EN 60079-1: 2014 EN IEC 60079-7: 2015 + A1: 2018 EN 60079-31: 2014

Directive 2014/30/EU: Electromagnetic Compatibility Directive (EMC)

Standards applied:	EN 61000-6-1:2007 EN 61000-6-2:2005 EN 61000-6-3:2007 / A1:2011 / AC: 2012 EN 61000-6-4:2007 / A1: 2011
--------------------	--

Directive 2011/65/EU: Restriction of the use of certain hazardous substances in electrical and electronic equipment (RoHS)

The product and all the components contained within it are in accordance with the restriction of the use of hazardous substances in electrical and electronic equipment, including amendment by Directive 2015/863/EU.

Regulation (EC) 1907/2006: Registration, Evaluation, Authorisation and Restriction of Chemicals (REACH)

The product and all the components contained within it are free from substances of very high concern.

Other Standards and Regulations

EN 60529:1991 / A1:2000 / A2:2013 - Degrees of protection provided by enclosures (IP code) – enclosure rated IP66/67

UKCA Declaration of Conformity



On behalf of European Safety Systems Ltd., I declare that, on the date the equipment accompanied by this declaration is placed on the market, the equipment conforms with all technical and regulatory requirements of the above listed directives, regulations and standards.

This Declaration is issued under the sole responsibility of the manufacturer.

A handwritten signature in black ink, appearing to read 'Martin Streetz', written over a faint, illegible background.

Martin Streetz
Quality Assurance Manager

Document No.: DC-104_Issue_A
Date and Place of Issue: London, 12/09/2022